

Aspartamide polyhydroxamic acids - synthesis and iron(III) complexes

Jakopović, Maja; Zorc, Branka; Biruš, Mladen; Butula, Ivan

Source / Izvornik: **Croatica Chemica Acta, 1996, 69, 267 - 279**

Journal article, Published version

Rad u časopisu, Objavljena verzija rada (izdavačev PDF)

Permanent link / Trajna poveznica: <https://um.nsk.hr/um:nbn:hr:163:703198>

Rights / Prava: [In copyright](#)/[Zaštićeno autorskim pravom.](#)

Download date / Datum preuzimanja: **2024-09-13**



Repository / Repozitorij:

[Repository of Faculty of Pharmacy and Biochemistry University of Zagreb](#)



Aspartamide Polyhydroxamic Acids – Synthesis and Iron(III) Complexes

Maja Jakopović,[#] Branka Zorc, Mladen Biruš, and Ivan Butula*

Faculty of Pharmacy and Biochemistry, University of Zagreb,
A. Kovačića 1, 10000 Zagreb, Croatia

Received July 14, 1995; revised November 16, 1995; accepted December 4, 1995

Several linear and cross-linked poly[α,β -(*N*-hydroxy-D,L-aspartamide)] derivatives (polyhydroxamic acids) were synthesized by aminolysis of poly-D,L-(2,5-dioxo-1,3-pyrrolidinediyl) (polysuccinimide; PSI) with the corresponding hydroxylamines. Aminolysis of the succinimide (SI) units in PSI with hydroxylamine or *N*-methylhydroxylamine was either complete or only partial, depending on the molar ratio of the SI-units and the hydroxylamine. Copolymers with partially opened SI rings were subjected to further aminolysis by 2-aminoethanol, di(2-hydroxyethyl)amine, butylamine, 2-phenylethylamine, 1,2-diaminoethane, and 1,6-diaminohexane. Use of diamines led to cross-linked polymers. Polyhydroxamic acids differed in the average relative molecular mass, the number and spacing between the hydroxamic acid groups and in their solubility.

The polyhydroxamic acids formed colored complexes with the iron(III) ions. Stability constants for the iron(III)-poly[α,β -(*N*-hydroxy)-D,L-aspartamide] complexes were determined by spectrophotometric titration. Values of the equilibrium quotients at 25 °C were calculated and confirmed to be: $Q_1 = (1.0 \pm 0.4) \times 10^2$, $Q_2 = (1.3 \pm 0.7) \times 10^{-2}$.

INTRODUCTION

Polyaspartamides are highly versatile polymers and have been known in the literature for many years.¹ They can be readily prepared with various substituents on amide nitrogens by aminolysis of poly-D,L-(2,5-dioxo-1,3-pyr-

[#] Present address: PLIVA-Research Institute, Prilaz baruna Filipovića 25, 10000 Zagreb, Croatia

* Author to whom correspondence should be addressed.

rolidinediyl) (polysuccinimide; PSI).¹⁻³ PSI is a reactive linear polyimide which can be prepared by polycondensation of aspartic acid in the presence of phosphoric acid.^{4,5} The opening of the imide rings by amines proceeds at random so that the resulting polymer finally consists of both α and β units. It is also known that racemization of the chiral carbon atom of the aspartic unit occurs during the polycondensation of aspartic acid to PSI, so the resulting PSI and the ultimately generated polymers have the DL configuration. Although the reaction of PSI with amines has been described in several papers,¹⁻³ hydroxylamines have not been used as the aminolyzing agents so far. As one can presume, aminolysis with hydroxylamines would lead to polyhydroxamic acids. The current interest in the chemistry of hydroxamic (HA) and polyhydroxamic acids is related to the variety of their pharmaceutical and industrial applications, as well as to their role as a model for natural siderophores.⁶ Naturally occurring hydroxamic acids have 1-3 hydroxamic functional groups. For example, desferrioxamine B, a well known drug in the therapy of Cooleys anemia, is a tripeptide bearing three hydroxamic acid residues. Several synthetic hydroxamic acid polymers were synthesized by Winston and Kirchner.^{7,8} The authors described two types of vinyl polymers bearing hydroxamic groups bound directly to the main chain or *via* amino acid spacers. The polymers also varied in the number of atoms spaced between the neighbouring hydroxamic groups. Some ion exchange resins, based on hydroxamic acids, have been also synthesized. For example, anhydride components in styrene-maleic anhydride copolymers or styrene-maleic anhydride-divinylbenzene copolymers reacted with hydroxylamine and gave the corresponding hydroxamic acid copolymers.^{9,10}

In this paper, the synthesis of various *N*-hydroxy-polyaspartamides (polyhydroxamic acids)¹¹ and the formation of iron(III) complexes with poly[α,β -(*N*-hydroxy)-D,L-aspartamide] is described.

EXPERIMENTAL

Chemicals

L-aspartic acid was purchased from Kemika (Zagreb). Dry *N,N*-dimethylformamide (DMF) was prepared by distillation with toluene and kept over molecular sieves 4A. Water was double distilled from alkaline KMnO_4 in an all-glass apparatus. Yields of the chemical reactions were not optimized.

Measurements

IR spectra were recorded on a Perkin-Elmer 457 spectrophotometer and UV-VIS spectra on a Pye Unicam SP-100 and Hewlett Packard 8452A spectrophotometer. Orion Research Model 701 pH-meter supplied by Orion Ross Combination pH electrode model 8102 was used for the pH measurements. Viscosity measurements were carried out at 25 °C using an Ostwald viscosimeter, with the flow time for water from 100 to 200 s.

*Procedures**Poly(D,L-succinimide) (PSI, 1a-j)*

PSI **1a-d** were synthesized by treating 14.8–59.0 g (0.111–0.443 mol) L-aspartic acid with phosphoric acid (4–17 mL), under reduced pressure in a rotary evaporator, at 160–180 °C, for 1.0–2.5 hours according to the procedure described earlier.^{2,12} Fractional precipitation of **1d** was carried out by pouring a solution of 31.5 g of PSI in DMF (195 mL) into ethanol (95 mL) at 70 °C. After slow cooling to room temperature, 10.4 g (33%) of **1e** was isolated by filtration. The mother liquor was heated to 70 °C and additional ethanol (10 mL) was added. After cooling to room temperature, 5.67 g (18%) of **1f** had precipitated. The procedure was repeated three times with 18, 20 and 50 mL ethanol and polymers **1g-i** were isolated. Product **1j** was prepared by evaporation of the last mother liquor. All products were dried for 24 hours under reduced pressure over P₂O₅ at 50 °C. Yields: 4.41 g (14%) **1g**; 3.15 g (10%) **1h**; 3.15 g (10%) **1i**; 3.78 g (12%) **1j**. IR (KBr): ν_{\max} 1780, 1715 cm⁻¹.

Poly[α,β -(N-hydroxy-D,L-aspartamide)] (PHA, 2a)

To a solution of 1.00 g (0.010 mol) PSI **1a-e** in DMF (30 mL), hydroxylamine (0.026 mol at the beginning and 0.026 mol after 6 hours) in DMF (15 mL) was added. The reaction mixture was stirred for 17 hours at room temperature. A precipitate had formed which was isolated by filtration, treated with acetone/methanol/acetic acid mixture (2:1:0.1) (30 mL), filtered again, washed three times with 10 mL acetone/methanol mixture (2:1) and dried for 22 hours over P₂O₅ under reduced pressure. Yield: 1.10–1.21 g (82–90%); m.p. 135–158 °C (decomp.); IR (KBr): ν_{\max} 3700–2700, 1650, 1525, 1400 cm⁻¹.

Anal. calcd for* C₄H₆N₂O₃ (130.10): C 36.93, H 4.65, N 21.53; found: C 36.22, H 5.38, N 21.03

Poly[α,β -(N-hydroxy-N-methyl-D,L-aspartamide)] (PMHA, 2b)

To a solution of 2.21 g (0.023 mol) PSI **1e** in DMF (40 mL), *N*-methylhydroxylamine in DMF (45 mL) (3 portions of 0.057 mol: at the beginning, after 20 and after 44 hours). The reaction mixture was stirred for 49 hours at room temperature. The solution was evaporated under reduced pressure to a smaller volume (20 mL), diluted with water (80 mL), acidified with glacial acetic acid to pH 4, dialyzed for 4 days against distilled water using SPECTRA/POR- Molecular Porous Membrane Tubing with a molecular mass cut-off of 3500 and lyophilized. The product, **2b**, was dried for 24 hours over P₂O₅ under reduced pressure. Yield: 1.88 g (57%); m.p. 175–185 °C (decomp.); IR (KBr): ν_{\max} 3700–2700, 1710, 1650 (broad), 1525, 1400 cm⁻¹.

Poly[α,β -(N-hydroxy-DL-aspartamide)]-poly(D,L-succinimide) 1:1 (PHA-PSI :1, 2c)

Solution of hydroxylamine (0.010 mol) in DMF (10 mL) was added to a solution of 2.00 g (0.021 mol) PSI **1e** in DMF (13 mL). The reaction mixture was stirred for 21 hours at room temperature. The solution was evaporated under reduced pressure. The residue was worked up with ethanol (20 mL) and glacial acetic acid (5 mL). The precipitated product was filtered off, washed three times with diluted ethanol (40%,

* The analysis is not acceptable, probably due to hygroscopicity of the polymer.

10 mL) and dried under reduced pressure. Yield: 1.86 g (80%); m.p. > 200 °C (decomp.); IR (KBr): ν_{\max} 3700–2700, 1780, 1710, 1650, 1520, 1390, 1360 cm^{-1} .

Poly[α,β -(*N*-hydroxy-*D,L*-aspartamide)]-*poly*(*D,L*-succinimide) 1:2 (PHA-PSI 1:2, **2d**)

To a solution of 2.00 g (0.021 mol) PSI **1c** in DMF (13 mL), 0.48 g (0.007 mol) hydroxylamine hydrochloride and 1.40 g (0.014 mol) TEA was added. The reaction mixture was stirred for 20 hours at room temperature. TEA HCl was filtered off and washed three times with DMF. The mother liquor was evaporated and the product was isolated in the same way as **2c**. Yield: 2.10 g (95%); m.p. > 200 °C (decomp.); IR (KBr): ν_{\max} 3700–2700, 1780, 1710, 1650, 1530, 1400, 1360 cm^{-1} .

Poly[α,β -(*N*-hydroxy-*D,L*-aspartamide)]-*poly*[α,β -(*N*-2-hydroxyethyl-*D,L*-aspartamide)] 1:1 (PHA-PHEA 1:1, **2e**)

Method a) To a solution of 0.80 g (0.007 mol) PHA-PSI 1:1 (**2c**) in DMF (20 mL), 1.72 g (0.028 mol) ethanolamine was added. The reaction mixture was stirred for 20 hours at room temperature. The solution was evaporated under reduced pressure. The residue was worked up with acetone/methanol/acetic acid mixture (2:1:0.1) (30 mL). The precipitated product was filtered off, washed three times with acetone/methanol mixture (2:1) (10 mL) and dried for 22 hours over P_2O_5 under reduced pressure. Yield: 0.88 g (87%); m.p. > 200 °C (decomp.); IR (KBr): ν_{\max} 3700–2700, 1660, 1530 cm^{-1} .

Method b) To a solution of 0.50 g (0.005 mol) PSI **1e** in DMF (10 mL), 0.31 g (0.003 mol) ethanolamine in DMF (2 mL) was added. After 1 hour the same amount of ethanolamine was added again. The reaction mixture was stirred for 2 hours at room temperature. The solvent was evaporated under reduced pressure and the residue was worked up with methanol/acetic acid mixture 3:0.1. The precipitated product PHEA-PSI was washed several times with the same solvent mixture and finally with acetone. The PHEA:PSI ratio in the product was estimated from IR spectrum as 1:1. After drying under reduced pressure, 0.50 g of the product was dissolved in DMF (15 mL). Hydroxylamine (2 \times 0.005 mol) in DMF (14 mL) was added in two portions (immediately and after 6 hours). After stirring for 23 hours at room temperature, the reaction mixture was evaporated under reduced pressure. The isolation procedure was the same as in method a. Yield: 0.63 g (85%).

Poly[α,β -(*N*-hydroxy-*D,L*-aspartamide)]-*poly*[α,β -(*N*-2-hydroxyethyl-*D,L*-aspartamide)] 1:2 (PHA-PHEA 1:2, **2f**)

Method a) An analogous procedure as for **2e**, method a. The starting materials were: 0.50 g (0.005 mol) PHA-PSI 1:2 (**2d**), 1.41 g (0.023 mol) ethanolamine and DMF (12 mL). Yield: 0.54 g (79%); m.p. > 200 °C (decomp.); IR (KBr): ν_{\max} 3700–2700, 1660, 1530 cm^{-1} .

Method b) An analogous procedure as for **2e**, method b. The molar ratio PSI:ethanolamine was 3:2. Yield: 0.52 g (76%).

Poly[α,β -(*N*-hydroxy-*D,L*-aspartamide)]-*poly*[α,β -(*N,N*-di-2-hydroxyethyl-*D,L*-aspartamide)] 1:1 (PHA-PDHEA 1:1, **2g**)

An analogous procedure as for **2e**, method a. The starting materials were: 0.50 g (0.004 mol) PHA-PSI 1:1 (**2c**), 1.85 g (0.018 mol) diethanolamine and DMF (12 mL). Yield: 0.52 g (72%); m.p. > 200 °C (decomp.); IR (KBr): ν_{\max} 3700–2700, 1660, 1530 cm^{-1} .

*Poly[α,β -(*N*-hydroxy-*D,L*-aspartamide)]-poly[α,β -(*N*-butyl-*D,L*-aspartamide)] 1:2
(PHA-PBA 1:2, **2h**)*

An analogous procedure as for **2e**, method a. The starting materials were: 0.80 g (0.007 mol) PHA-PSI 1:2 (**2d**), 1.35 g (0.018 mol) butylamine and DMF (20 mL). Yield: 1.08 g (93%); m.p. > 200 °C (decomp.); IR (KBr): ν_{\max} 3700–2700, 1660, 1530 cm^{-1} .

*Poly[α,β -(*N*-hydroxy-*D,L*-aspartamide)]-poly[α,β -(*N*-2-phenylethyl-*D,L*-aspartamide)]
1:1 (PHA-PFEA 1:1, **2i**)*

To a solution of 6.00 g (0.062 mol) PSI **1b** in DMF (50 mL), 3.75 g (0.031 mol) 2-phenylethylamine was added. The reaction mixture was left at room temperature for 24 hours. Hydroxylamine (2 \times 0.078 mol) in DMF (20 mL) was added in two portions (immediately and after 6 hours). The reaction mixture was stirred at room temperature for 24 hours and evaporated under reduced pressure. The residue was dissolved in ethyl acetate (50 mL) and extracted with water/HCl (50 mL) (pH 1). The organic layer was dried over sodium-sulfate and evaporated under reduced pressure. The residue was worked up with acetone/ether mixture (1:2). The precipitated product was filtered off. Yield: 6.32 g (66%); m.p. > 150 °C (decomp.); IR (KBr): ν_{\max} 3700–2700, 1650, 1525 cm^{-1} .

*Cross-linking of poly[α,β -(*N*-hydroxy-*D,L*-aspartamide)]-poly(*D,L*-succinimide)
copolymers with diamine. General procedure.*

To a solution of PHA-PSI 1:1 (**2c**) or PHA-PSI 1:2 (**2d**) containing 0.003 mol of SI units in DMF (30 mL), 0.31 g (0.003 mol) TEA and 0.0015 mol 1,2-diaminoethane or 1,6-diaminohexane was added. Reaction mixture was stirred for 20–68 hours at room temperature. Solvent was evaporated under reduced pressure, the residue was diluted with water (30 mL) and acidified with acetic acid to pH 3. The precipitated product was filtered off, washed several times with acetone, and dried over P_2O_5 under reduced pressure. Yields: PHA-ECPA 1:1 (**2j**), (85%); PHA-ECPA 1:2 (**2k**), (72%); PHA-HCPA (**2l**), (81%).

The products **2j–2l** had m.p. > 200 °C. All IR spectra had absorptions at 1650–1640 and 1520–1510 cm^{-1} .

RESULTS AND DISCUSSION

Polysuccinimides **1a–j** and polyhydroxamic acids **2a–l** were synthesized according to Scheme 1. The chemical structures of polymers **2a–l** are shown in Figure 1.

The first step was the synthesis of polysuccinimides (**1**) by thermal polycondensation of aspartic acid (*L*-Asp). PSI with several average relative molecular masses (M_r) could be prepared^{3,5} by variation of the reaction temperatures and duration of the reactions. Vlasak *et al.*³ had prepared several fractions of PSI by fractional precipitation of 1.6% DMF solutions into water at room temperature. The individual fractions were isolated by filtration and ultracentrifugation. In our experiments polycondensation was carried out under reduced pressure at 160–180 °C for 1.0–2.5 hours. Polymers **1a–d**

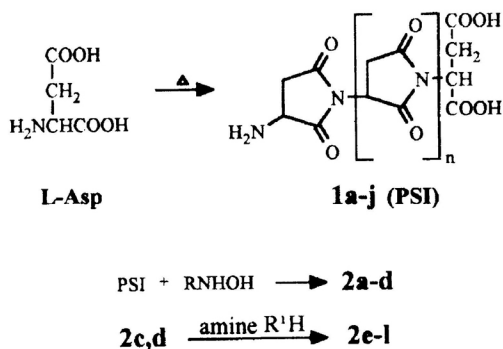

Scheme 1.

with a M_r range from 22000–225000 were isolated (Table I). Product **1d** was submitted to additional fractional precipitation. Fractionation conditions were investigated. The best results were achieved by precipitating PSI from a 14% DMF solution at 70 °C into absolute ethanol. Slow cooling to room temperature gave easily filterable products and ultracentrifugation was not

Figure 1. Structure of polyhydroxamic acids **2a-l**.

TABLE I

Polysuccinimide synthesis – the reaction conditions and yields

Temp./°C	Reaction		Product	
	Time/h	Yield/%	M_r	1a-d
180	2.5*	99	225000	a
160	2.5*	89	42500	b
160	2.5	98	40000	c
160	1.0	86	22000	d

* 2.5 hours plus time for heating from room temperature to 180 or 160 °C

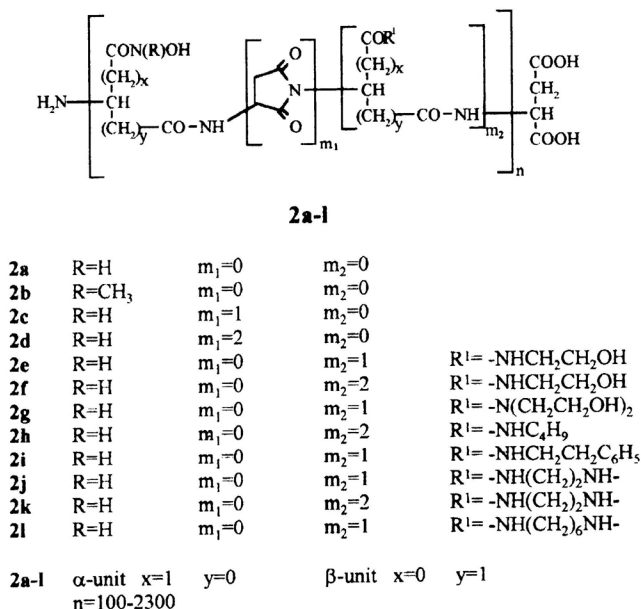
necessary. In this way six fractions, **1e-j**, with M_r from 11000–33100 were prepared (Table II). The M_r was determined according to the Mark-Houwink equation³ $[\eta] = 1.32 \times 10^{-2} \times M_r^{0.76}$ by measuring the reduced viscosity at a concentration range from 4 to 10 mg mL⁻¹.

The second step was the aminolysis of polysuccinimide with the corresponding amines in DMF. If hydroxylamine itself was used in a molar excess over SI units, all SI rings were opened. If the molar ratio between hydroxylamine and the SI units was less than 1:1, partial aminolysis occurred and only every second or third SI ring was opened. Polymers PHA (**2a**) and PMHA (**2b**) were prepared by complete aminolysis of PSI with hydroxylamine and *N*-methylhydroxylamine, respectively. Copolymers PHA-PSI 1:1 (**2c**) and PHA-PSI 1:2 (**2d**) were prepared by partial aminolysis of PSI with the hydroxylamine.

The remaining SI rings in **2c** and **2d** were opened with another amine R¹H: 2-aminoethanol (ethanolamine), di(2-hydroxyethyl)amine (diethanolamine), butylamine and 2-phenylethylamine, respectively, giving copolymers PHA-PHEA 1:1 (**2e**), PHA-PHEA 1:2 (**2f**), PHA-PDHEA 1:1 (**2g**), PHA-PBA 1:2 (**2h**) and PHA-PFEA (**2i**) (see Table III). These copolymers could be prepared in an

TABLE II

Fractions from the precipitation of PSI **1d**

1e-j	Yield/%	M_r
e	33	33100
f	18	24800
g	14	16000
h	10	14700
i	10	13600

opposite way by aminolyzing PSI first with the amine R¹H and then with hydroxylamine. Aminolysis of **2c** and **2d** with diamines (1,2-diaminoethane or 1,6-diaminohexane) led to cross-linked polymers **2j-l**. The molar ratio of SI units and diamines was 2:1 in order to achieve crosslinking, e.g. utilizing both amino groups for crosslinking reaction. In this way, copolymers PHA-ECPA 1:1 (**2j**), PHA-ECPA 1:2 (**2k**) and PHA-HCPA 1:1 (**2l**) were prepared. From the IR spectrum of polymer **2j**, we noted that the opening of the SI units was not completely done. Characterization of polymers **2a-l** could easily be done by IR spectrophotometry. The imide carbonyl groups showed absorptions at 1780 and 1715 cm⁻¹ and the amide carbonyl groups at 1650–1640 (amid I) and 1530–1520 cm⁻¹ (amid II). The molar ratio of aspartamide and SI units could be approximately estimated from IR spectra by comparing the ratio of the main absorptions of the amide and imide carbonyl groups. In this way, the general structure of **2c** and **2d** was determined. Copolymers **2e-l**, prepared from **2c** and **2d**, should have the same ratio of *N*-hydroxy-aspartamide to *N*-substituted aspartamide units since all SI rings were converted to aspartamides.

One could either use the hydroxylamine base prepared a) from hydroxylamine hydrochloride and triethylamine (TEA) or b) from hydroxylamine hydrochloride and TEA together with the starting polymer. A two fold excess of TEA was recommended in order to prevent formation of hydroxamic acid-hydroxylamine salts. For the same reason, reactions **2c** and **2d** with amine R¹H were carried out with a molar excess of R¹H over SI units, or in combination with TEA.

Products **2a-l** differed in the average relative molecular mass, in spacing between HA groups and in their solubility. The average relative molecular mass depended upon the starting PSI polymer.⁵ The spacing between two neighbouring HA groups was a consequence of the molar ratio of PSI and hydroxylamine. The solubility of the polymers depended upon both the molar ratio of PSI and of hydroxylamine in the second reaction step (partial aminolysis gave water insoluble polymers **2c** and **2d**) and the type of amine used in the third step. Polymers **2a,b,e-g** were water soluble, they had no succinimide units in their structure. They were prepared by complete aminolysis of PSI with hydroxylamine or with *N*-methylhydroxylamine, or by partial aminolysis of PSI with hydroxylamine followed by aminolysis with ethanolamine or diethanolamine. In addition to the HA groups in the polymer, these water insoluble polymers had either SI units (**2c,d**), or buthylamino groups (**2h**), or 2-phenylethyl-amino groups (**2i**) or they were cross-linked (**2j-l**).

All reactions were carried out in DMF at room temperature. PSI was dissolved in a hot solvent, and after cooling to room temperature, the solution was used for further reactions. The calculated molar amounts of PSI in the experimental part represent the moles of SI units. Reactants, reaction times and yields of aminolysis reactions are given in Table III.

Polyhydroxamic acids described in this paper formed colored complexes with iron(III) ions. Poly[α,β -(*N*-hydroxy)-D,L-aspartamide] (PHA, **2a**) of a M_r 24800 was chosen as the preferred iron(III) chelator in our experiments. This hydroxamic acid was found to be very stable in acid aqueous solutions (less than 3% of the PHA hydrolyzed in 0.1 mol L⁻¹ HClO₄ for 6 hours). The formation constants of PHA-Fe(III) complexes in acid aqueous solutions were determined by spectrophotometric measurements in the UV-VIS spectral range. The concentrations of all three reactants, *i.e.* iron(III), polyhydroxamic acid and the proton, were varied at constant ionic strength and temperature ($I = 2.00$ mol L⁻¹ H/NaClO₄; $t = 25$ °C). In acid solutions, at constant iron(III) and PHA concentration, variation of the proton concentration resulted in a spectral change, characteristic of the polydentate iron(III)-hydroxamate complexes. The results shown in Figure 2 are essentially the same as those reported for desferrioxamine B.^{13,14} A hypsochromic shift of the

TABLE III

Polyhydroxamic acids synthesis – the reaction conditions and yields

Polymer	Reaction				Product	
	Amine 1	Amine 2	Time/h	Yields/%	2a-l	Abbreviation
PSI	NH ₂ OH		23	82–90	a	PHA
PSI	CH ₃ NHOH		49	57	b	PMHA
PSI	NH ₂ OH		21	80	c	PHA-PSI 1:1
PSI	NH ₂ OH		20	95	d	PHA-PSI 1:2
PHA-PSI 1:1	NH ₂ CH ₂ CH ₂ OH		2	87	e	PHA-PHEA 1:1
PSI	NH ₂ CH ₂ CH ₂ OH	NH ₂ OH	2+23	85	e	PHA-PHEA 1:1
PHA-PSI 1:2	NH ₂ CH ₂ CH ₂ OH		23	79	f	PHA-PHEA 1:2
PSI	NH ₂ CH ₂ CH ₂ OH	NH ₂ OH	2+23	76	f	PHA-PHEA 1:2
PHA-PSI 1:1	NH(CH ₂ CH ₂ OH) ₂		44	72	g	PHA-PDHEA 1:1
PHA-PSI 1:2	C ₄ H ₉ NH ₂		36	93	h	PHA-PBA 1:2
PSI	NH ₂ CH ₂ CH ₂ C ₆ H ₅	NH ₂ OH	24+65	66	i	PHA-PFEA 1:1
PHA-PSI 1:1	NH ₂ (CH ₂) ₂ NH ₂		20	85	j	PHA-ECPA1:1
PHA-PSI 1:2	NH ₂ (CH ₂) ₂ NH ₂		68	97	k	PHA-ECPA 1:2
PHA-PSI 1:1	NH ₂ (CH ₂) ₆ NH ₂		42	81	l	PHA-HCPA 1:1

PSI – poly(D,L-succinimide)

PHA – poly[α,β -(*N*-hydroxy)-D,L-aspartamide]PMHA – poly[α,β -(*N*-hydroxy-*N*-methyl-D,L-aspartamide)]PHEA – poly[α,β -(*N*-2-hydroxyethyl)-D,L-aspartamide]PDHEA – poly[α,β -(*N,N*-di-2-hydroxyethyl)-D,L-aspartamide]PBA – poly[α,β -(*N*-butyl-D,L-aspartamide)]PFEA – poly[α,β -(*N*-2-phenylethyl-D,L-aspartamide)]PHA-ECPA – cross-linked poly[α,β -(*N*-hydroxy)-D,L-aspartamide]-poly(D,L-succinimide) with 1,2-diaminoethanePHA-HCPA – cross-linked poly[α,β -(*N*-hydroxy)-D,L-aspartamide]-poly(D,L-succinimide) with 1,6-diaminohexane

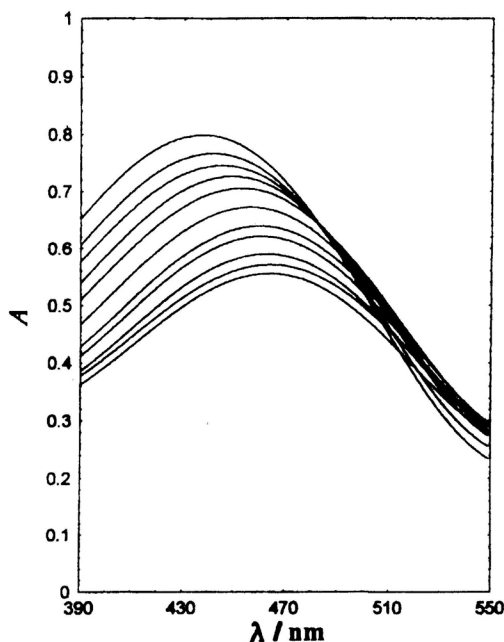
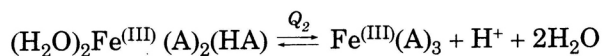
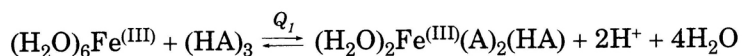

Figure 2. Absorption spectra of the PHA-Fe(III) system at different pH values. [HA unit] = 1.00×10^{-2} mol L $^{-1}$; [Fe(III)] = 3.00×10^{-4} mol L $^{-1}$; [HClO $_4$] = 0.031 (the lowest curve), 0.044, 0.058, 0.073, 0.100, 0.141, 0.199, 0.251, 0.316, 0.398, 0.501 mol L $^{-1}$ (the highest curve); $I = 2.00$ mol L $^{-1}$ (H/NaClO $_4$); $t = 25$ °C.

spectral maximum from 466 nm to 430 nm, along with an isobestic point at 485 nm observed by increasing the pH, are indicative of the dependence of the equilibrium on the proton concentration.



where symbol A represents the hydroxamate unit, $(\text{H}_2\text{O})_2\text{Fe}^{(\text{III})}(\text{A})_2(\text{HA})$ and $\text{Fe}^{(\text{III})}(\text{A})_3$ stands for the tetradentate and hexadentate coordinated iron complexes of PHA, respectively. A linear plot of $[\text{Fe}^{(\text{III})}]/A_{466}$ vs. $[\text{Fe}^{(\text{III})}]$ at 466 nm, shown in Figure 3, suggests a 1:1 molar ratio of iron(III) to the tetradentate unit of PHA. A slight bathochromic spectral shift at the lowest iron(III) concentration (see Figure 4) may indicate that, when there is not enough iron(III) for the tetradentate mode of coordination, the hexadentate

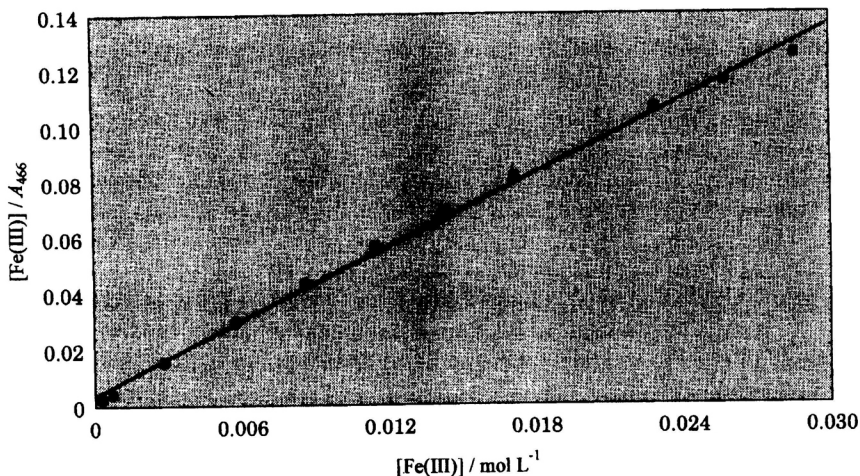

Figure 3. Dependence of $\text{Fe(III)}/A_{466}$ on iron(III) concentration. $[\text{HA unit}] = 2.95 \times 10^{-4} \text{ mol L}^{-1}$; $[\text{HClO}_4] = 0.10 \text{ mol L}^{-1}$; $I = 2.00 \text{ mol L}^{-1}$ (H/NaClO_4); $t = 25 \text{ }^\circ\text{C}$.

unit of PHA, which requires less iron(III) per mole of hydroxamic acid, becomes partly involved in the coordination process. It must be noted, however, that no evidence of a significant amount of the bidentate iron(III) coordinated to PHA was observed even at the highest iron(III) concentration used. The same behaviour had been reported for vinyl polymers bearing HA

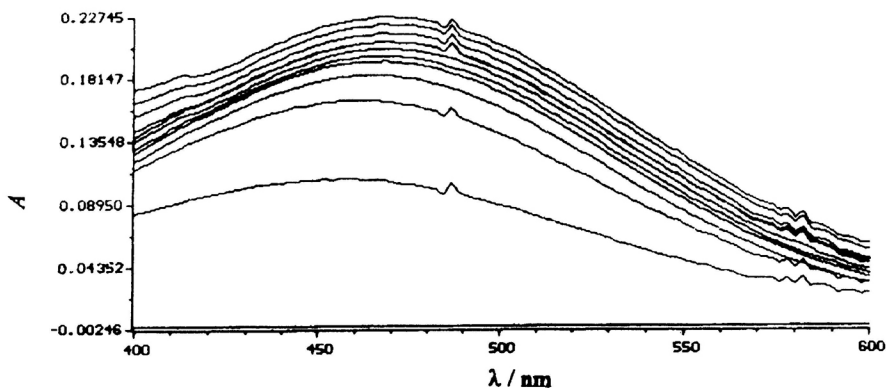

Figure 4. Absorption spectra of the PHA-Fe(III) system at different iron(III) concentrations $[\text{HA unit}] = 3.00 \times 10^{-4} \text{ mol L}^{-1}$; $[\text{HClO}_4] = 0.10 \text{ mol L}^{-1}$; $[\text{Fe(III)}] = 2.860 \times 10^{-4}$ (the lowest curve), 7.150×10^{-4} , 2.859×10^{-3} , 5.718×10^{-3} , 8.577×10^{-3} , 1.144×10^{-2} , 1.429×10^{-2} , 1.715×10^{-2} , 2.287×10^{-2} , 2.573×10^{-2} , $2.859 \times 10^{-2} \text{ mol L}^{-1}$ (the highest curve); $I = 2.00 \text{ mol L}^{-1}$ (H/NaClO_4); $t = 25 \text{ }^\circ\text{C}$.

functional groups.^{7,8} In contrast, desferrioxamine B forms a stable complex in a molar excess of iron(III), where one iron(III) bidentate is coordinated to one hydroxamate functionality.^{15,16}

Taking into account the above arguments, all the absorbance data at 466 nm were simultaneously fitted by a nonlinear curve-fitting program, assuming the formation of the tetradentate and hexadentate complexes. The values of the equilibrium quotients and the molar absorbance coefficients at 466 nm, calculated by fitting the function $A_{466} = \varepsilon_i(466)c_i$ to all experimental data points, are as follows: $Q_1 = (1.0 \pm 0.4) \times 10^2$, $Q_2 = (1.3 \pm 0.7) \times 10^{-2}$, $Q_1 = (2.06 \pm 0.05) \times 10^3 \text{ mol}^{-1} \text{ L cm}^{-1}$, and $Q_2 = (3.80 \pm 0.70) \times 10^3 \text{ mol}^{-1} \text{ L cm}^{-1}$. Symbol ε_i stands for molar absorbance coefficients while c_i are molar concentrations of the light absorbing species present in solutions, which depend on the total concentrations of all reactants and on the values of the complex stability quotients, Q_i .

Acknowledgement. – Financial support from the Croatian research Council is gratefully acknowledged.

REFERENCES

1. J. Kovacs, H. Nagy Kovacs, I. Könyves, J. Császár, T. Vajda, and H. Mix, *J. Org. Chem.* **26** (1961) 1084.
2. P. Neri, G. Antoni, F. Benvenuti, F. Cocola, and G. Gazzei, *J. Med. Chem.* **16** (1973) 893.
3. J. Vlasak, F. Rypaček, J. Drobnik, and V. Saudek, *J. Polym. Sci. Polym. Symp.* **66** (1979) 59.
4. J. Kovacs, I. Könyves, and A. Puztai, *Eperientia*, **9** (1953) 459.
5. E. Kokufuta, S. Suzuki, and K. Harada, *Bull. Chem. Soc. Japan*, **51** (1978) 1555.
6. B.F. Matzanke, G. Müller-Matzanke, and K.N. Raymond, *Siderophore Mediated Iron Transport: Chemistry, Biology and Physical Properties, in Physical Bioinorganic Chemistry*, T.M. Loehr, H. B. Grey, A.B.P. Lever, (Eds.), VCH Publishers, New York, 1989.
7. A. Winston and D. Kirchner, *Macromolecules*, **11** (1978) 597.
8. A. Winston, *Polym. News*, **10** (1984) 6.
9. E. Cocea, M. Grigoras, and M. Tutoveanu, *Bul. Inst. Politeh. Iasi* **11** (1965) 159–163.
10. D.D. Coffman, E.I. du Pont de Nemours & Co., *U.S. Pat.* 2,402,604, June 18, 1946; *C.A.* **40** (1946) 5942.
11. I. Butula, M. Jakopović, and B. Zorc, *Croat. Pat. Appl.* P931024A, June 12, 1995.
12. B. Zorc, M. Ljubić, S. Antolić, J. Filipović-Grčić, D. Maysinger, T. Alebić-Kolbah, and I. Jalšenjak, *Int. J. Pharm.* **99** (1993) 135.
13. M. Biruš, Z. Bradić, G. Krznarić, N. Kujundžić, M. Pribanić, P.C. Wilkins, and R.G. Wilkins, *Inorg. Chem.* **26** (1987) 1000.
14. B. Monzyk and A.I. Crumbliss, *J. Am. Chem. Soc.* **104** (1982) 4921.
15. M. Biruš, Z. Bradić, N. Kujundžić, and M. Pribanić, *Acta Pharm. Jugoslav.* **32** (1982) 163.
16. M. Biruš, Z. Bradić, N. Kujundžić, and M. Pribanić, *Inorg. Chim. Acta*, **56** (1981) L43.

SAŽETAK

Sinteza i željezo(III)-kompleksi polihidroksamskih kiselina

Maja Jakopović, Branka Zorc, Mladen Biruš i Ivan Butula

Sintetizirani su linearni i umreženi derivati poli[α,β -(*N*-hidroksi-D,L-aspartamida)] (polihidroksamske kiseline) aminolizom poli-D,L-(2,5-diokso-1,3-pirolidindil) (polisukcinimida; PSI) s odgovarajućim aminom. Provedena je potpuna ili djelomična aminoliza sukcinimidnih jedinica (SI jedinica) u PSI s hidroksilaminom ili metilhidroksilaminom. Kopolimeri s djelomično otvorenim sukcinimidnim prstenima podvrgnuti su daljnjoj aminolizi s 2-aminoetanolom, di(2-hidroksietil)aminom, butilaminom, 2-feniletilaminom, 1,2-diaminoetanolom i 1,6-diaminoheksanom. Upotrebom diamina dobiveni su umreženi polimeri. Sintetizirane polihidroksamske kiseline razlikuju se u prosječnoj relativnoj molekularnoj masi, broju i razmaku između hidroksamskih skupina te u topljivosti.

Polihidroksamske kiseline stvaraju obojene komplekse sa željezo(III) ionima. Konstante stabilnosti za kompleks željezo(III)-poli[α,β -(*N*-hidroksi)-D,L-aspartamid] određene su spektrofotometrijskom titracijom. Izračunane su sljedeće vrijednosti ravnotežnih kvocijenata: $Q_1 = (1.0 \pm 0.4) \times 10^2$, $Q_2 = (1.3 \pm 0.7) \times 10^{-2}$.